

Varenummer: 59GPN10001068

Beskrivelse: KLEE Prop for møtrik GPN 1000 / 1068 - NV 8

Mål

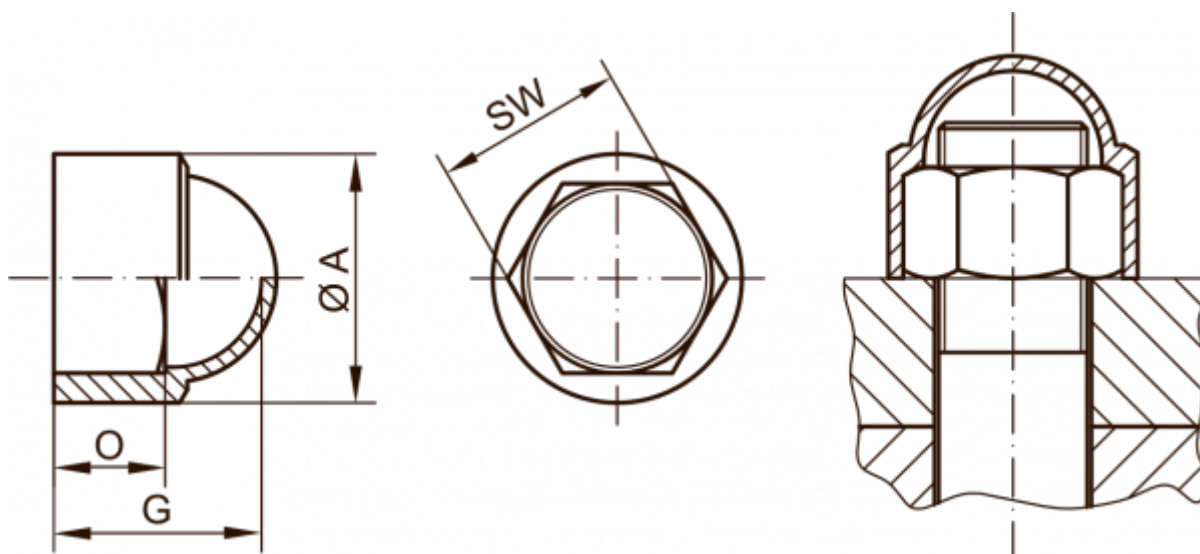

A	= 10.9
For	= M5
G	= 8
O	= 5
SW (Nøglevidde)	= 8